

VOW

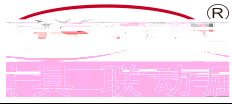

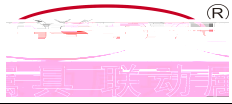

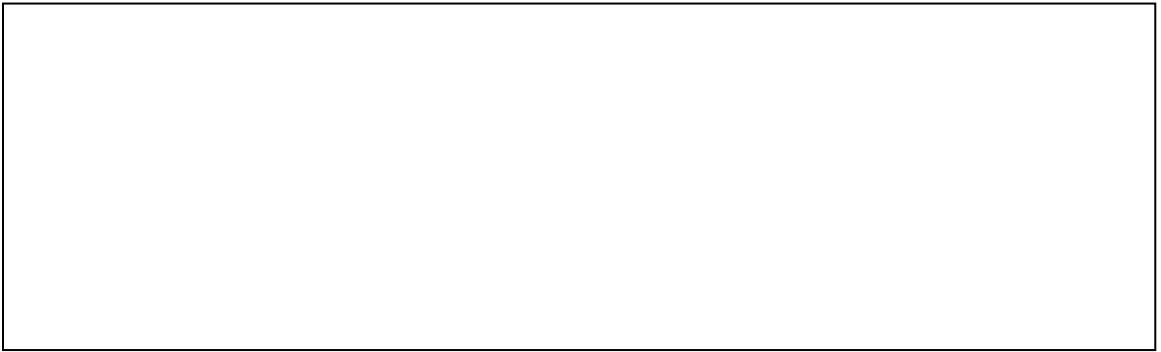

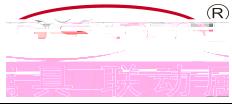
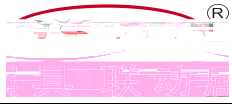



WHgMDHBO H

H

I O M

ГН

ГН

HH MDD

M H

D

DK

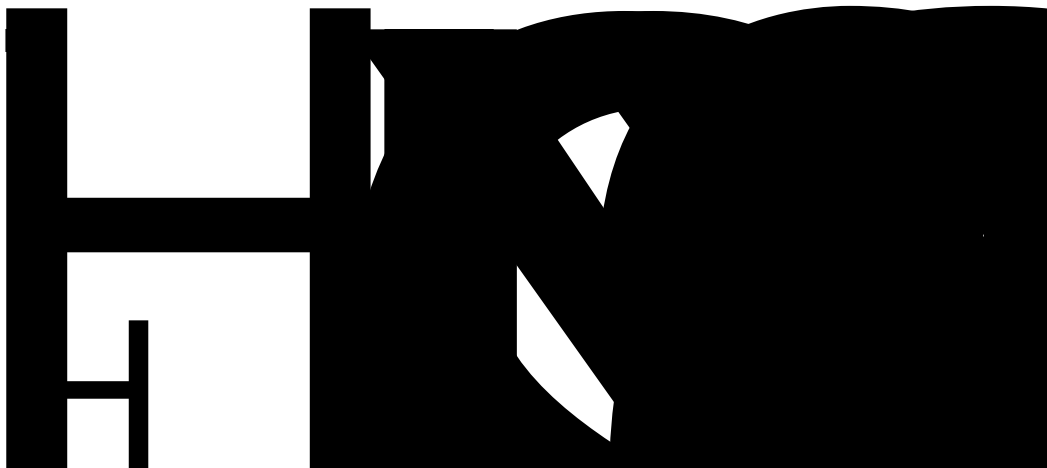

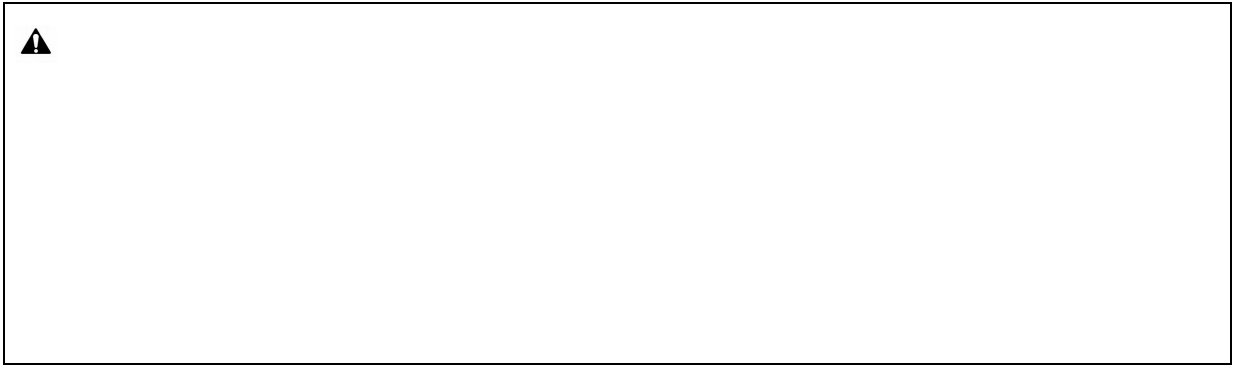
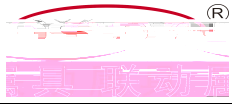



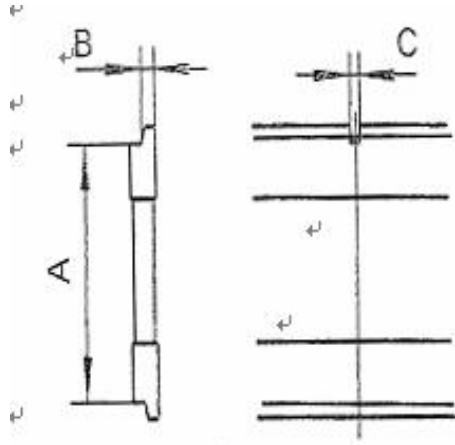



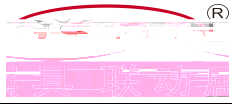

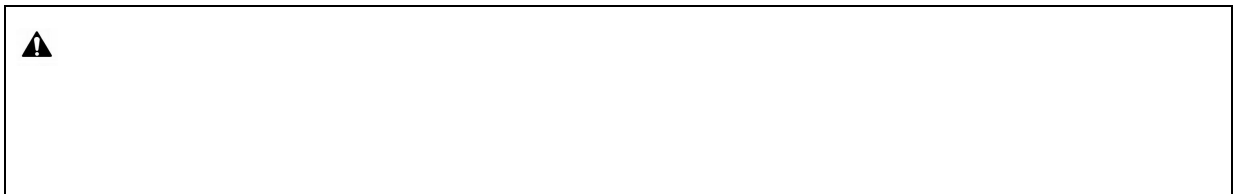
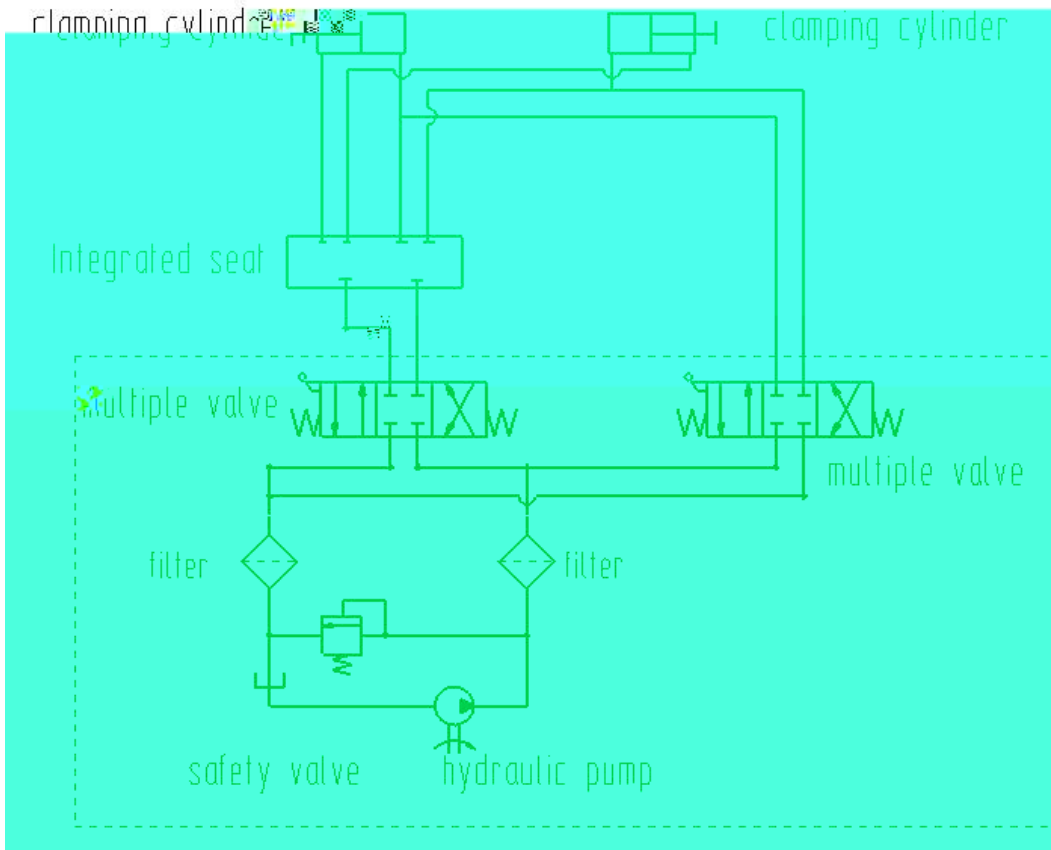

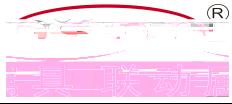

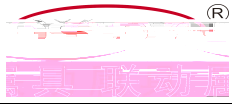

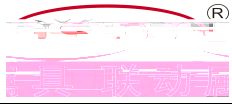

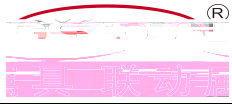

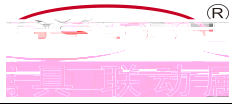

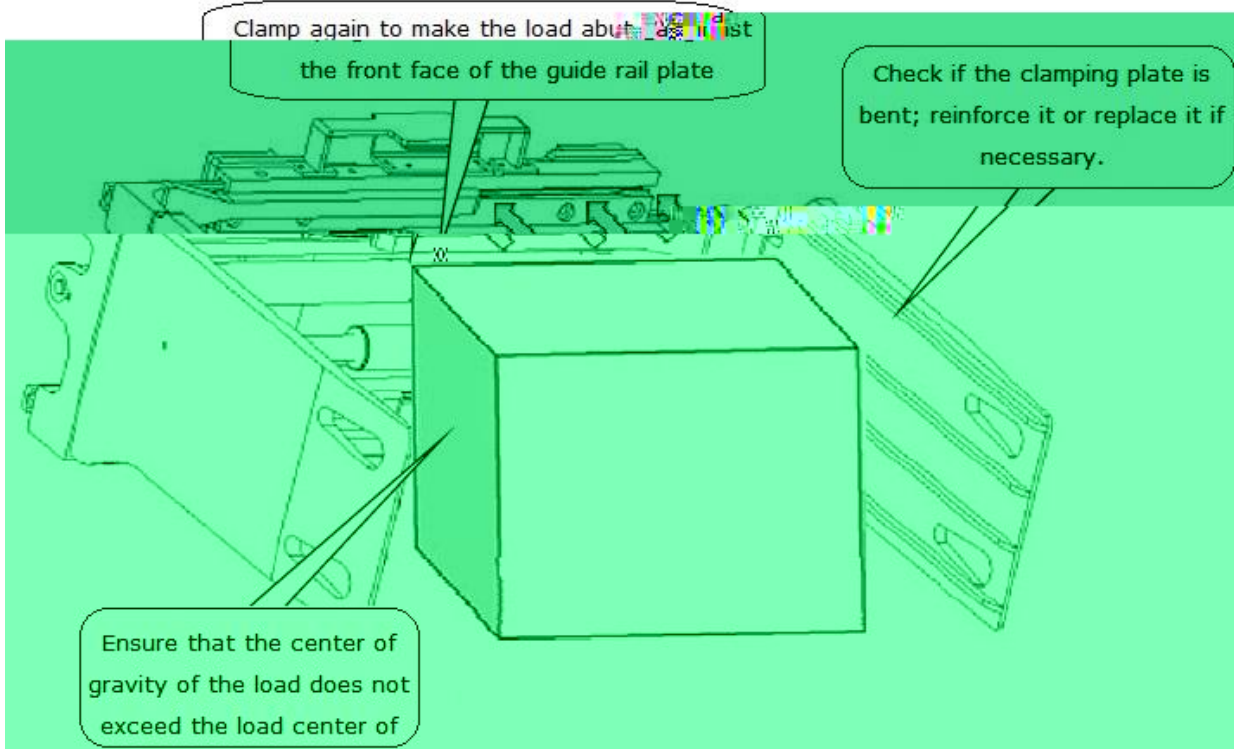

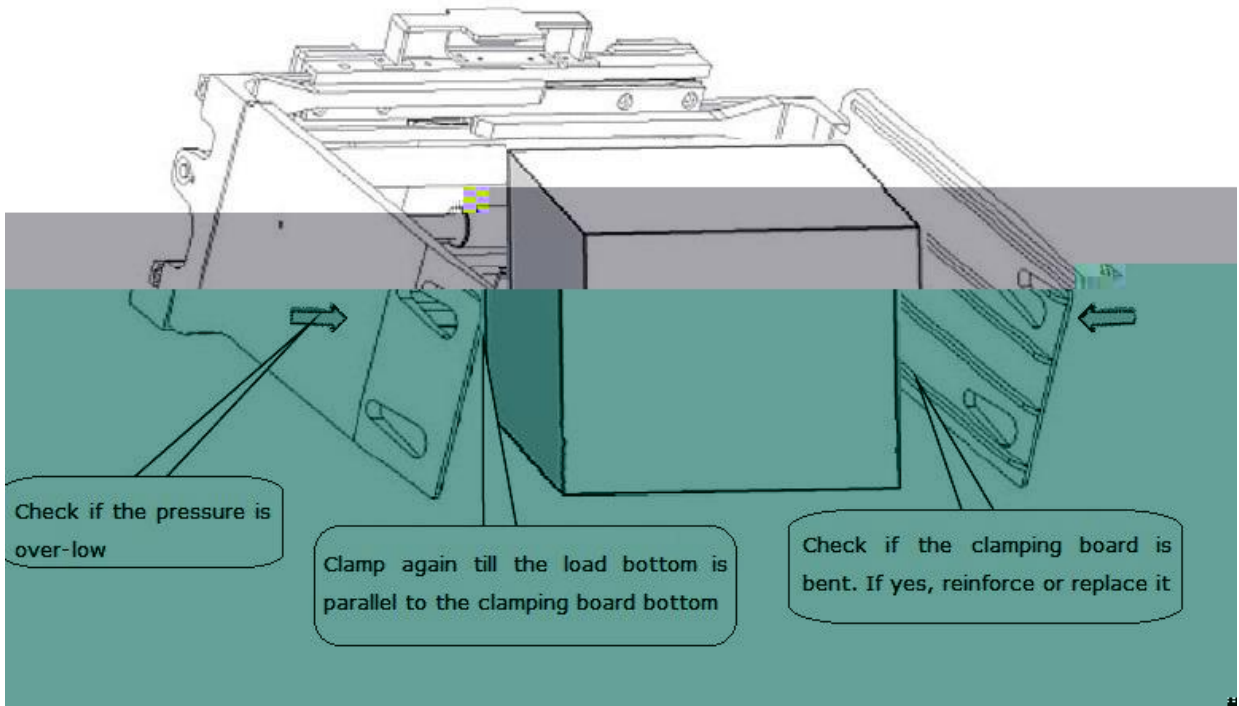

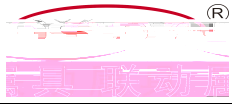

БФ

DTA@D O

M λā €λ /

